

- A**  Double Rail
- B**  Side Rail
- C**  Split Rail
- D**  5 Screws
- E**  Pole Connector
- F**  Pole
- G**  Round Base

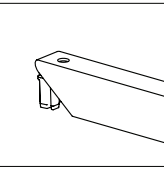

***Using a Phillips screw driver, assemble the frame first**

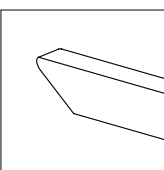
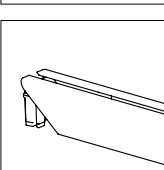
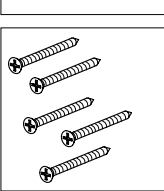
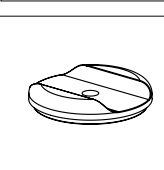
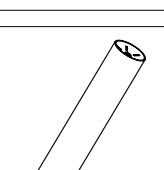
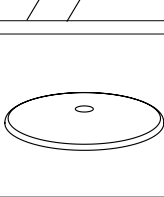
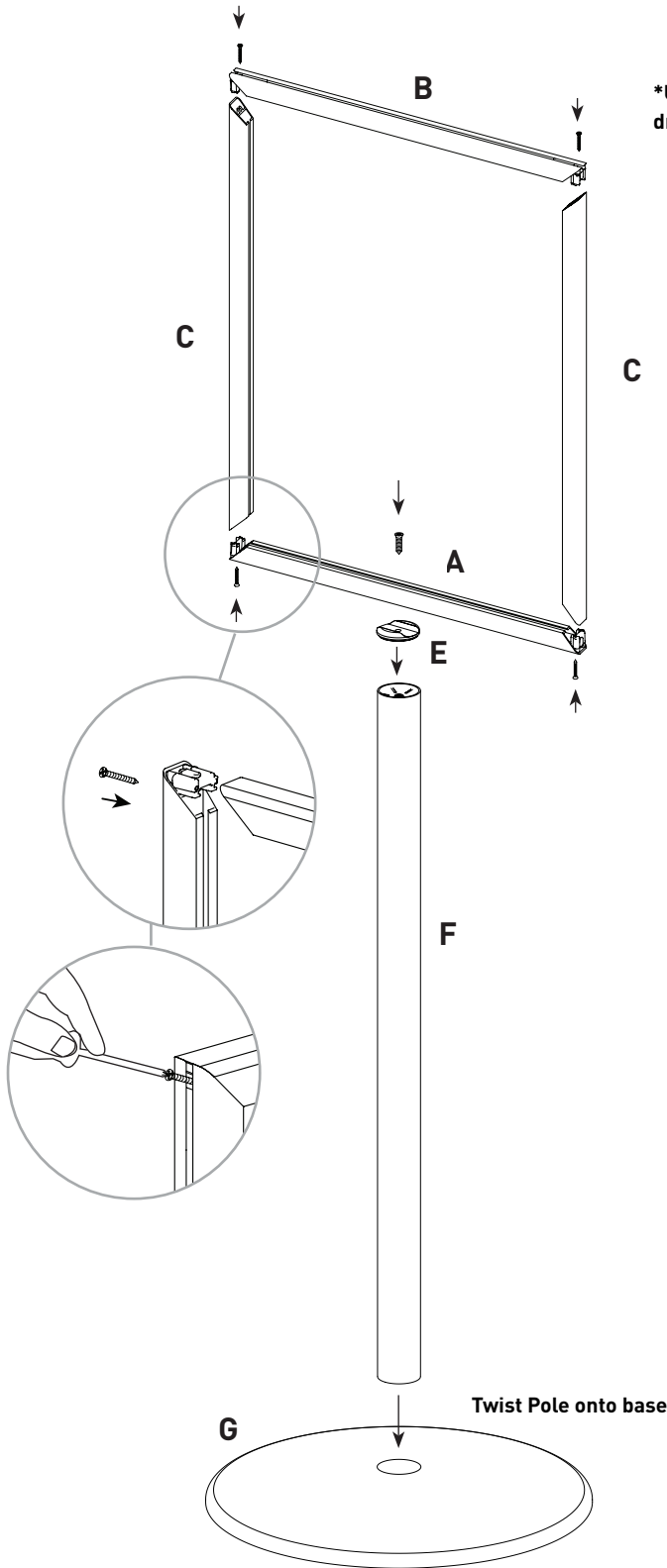